

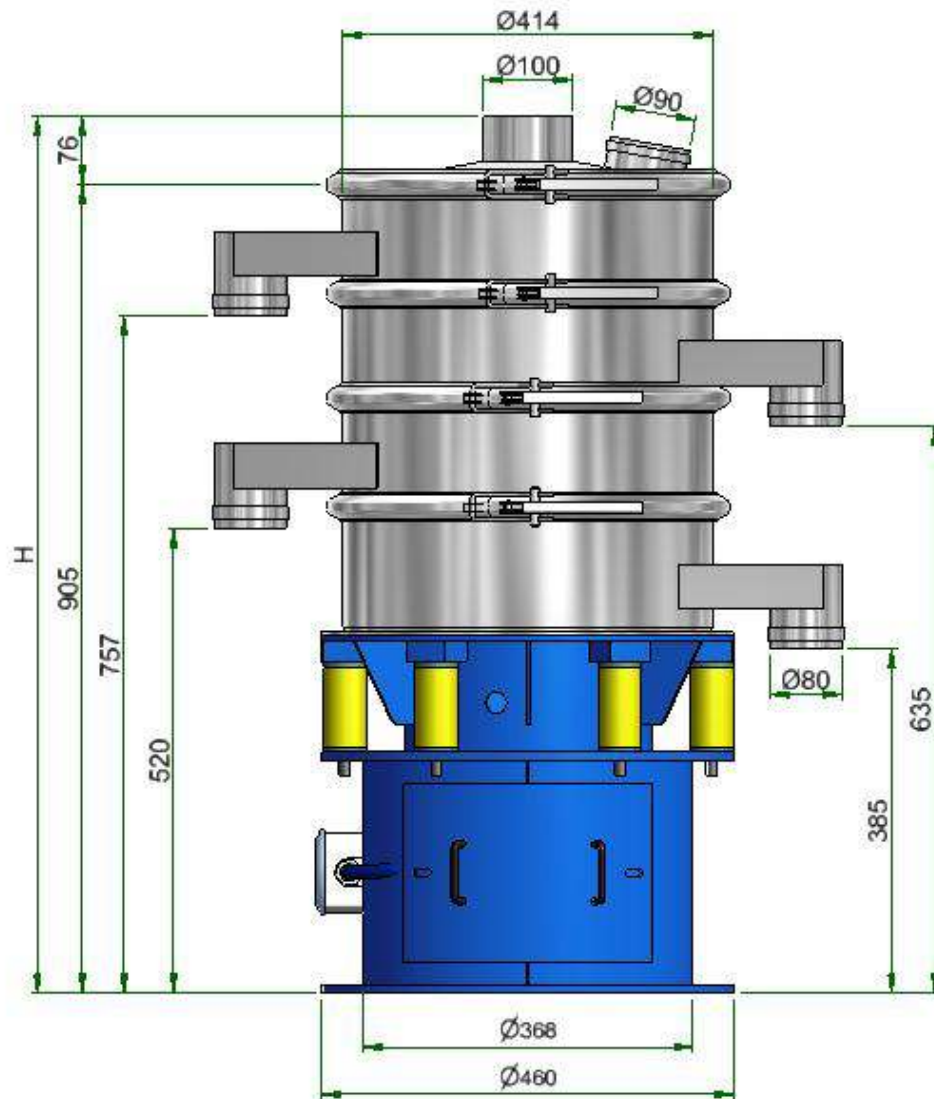

Dimensioni di ingombro separatore circolare MR 16



MODELLO MR 16

UNITA'	H		PESO	
	mm	in	kg	lb
MR 16 4 4 C	745	29.3	104	229
MR 16 4 4 4 C	860	33.8	114	251
MR 16 4 4 4 4 C	981	38.6	124	273