

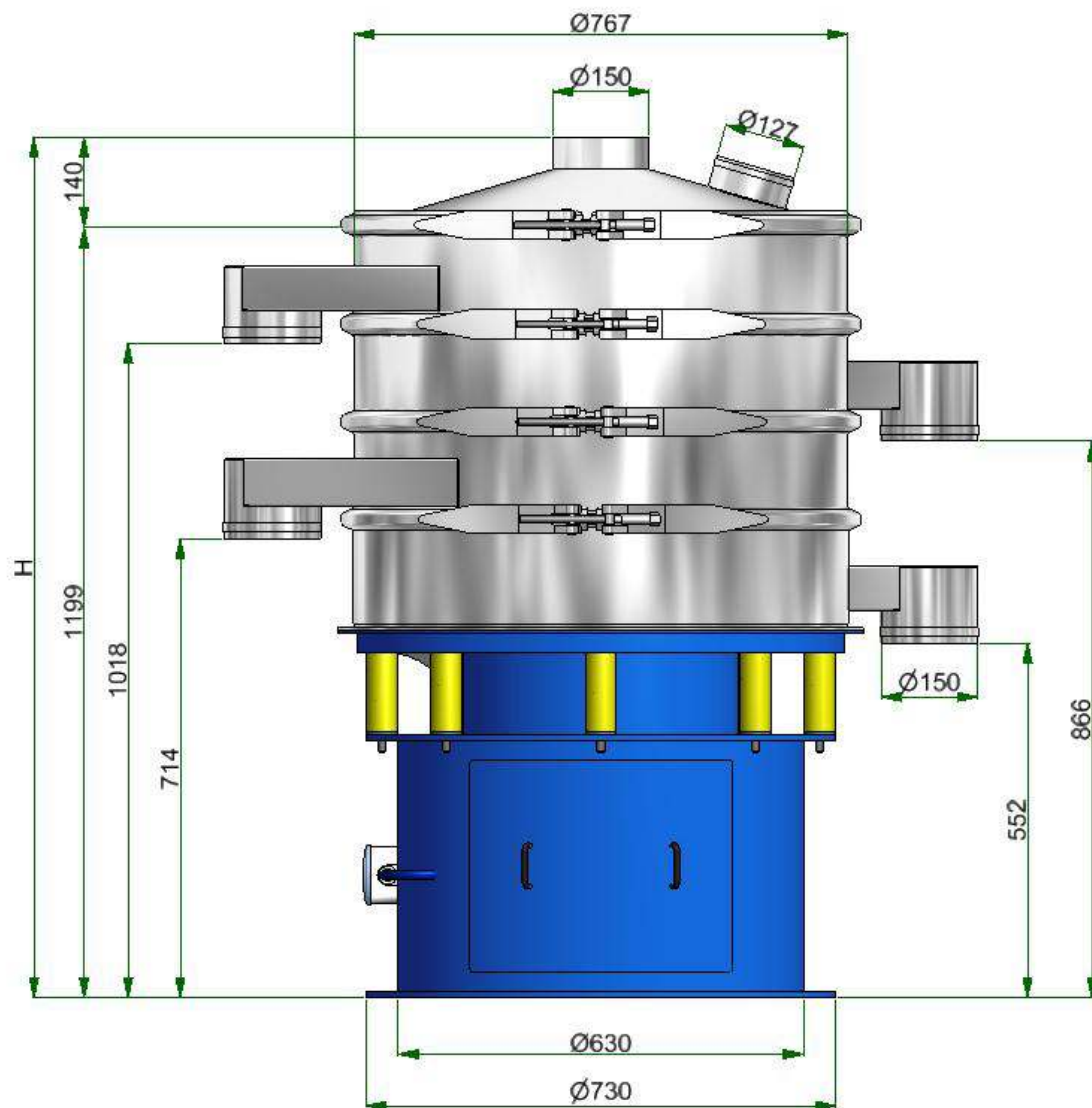

Dimensioni di ingombro separatore circolare MR 30



MODELLO MR 30

UNITA'	H		PESO	
	mm	in	kg	lb
MR 30 5 5 C	1028	40.5	280	617
MR 30 5 5 5 C	1180	46.8	300	661
MR 30 5 5 5 5 C	1339	52.7	320	705