

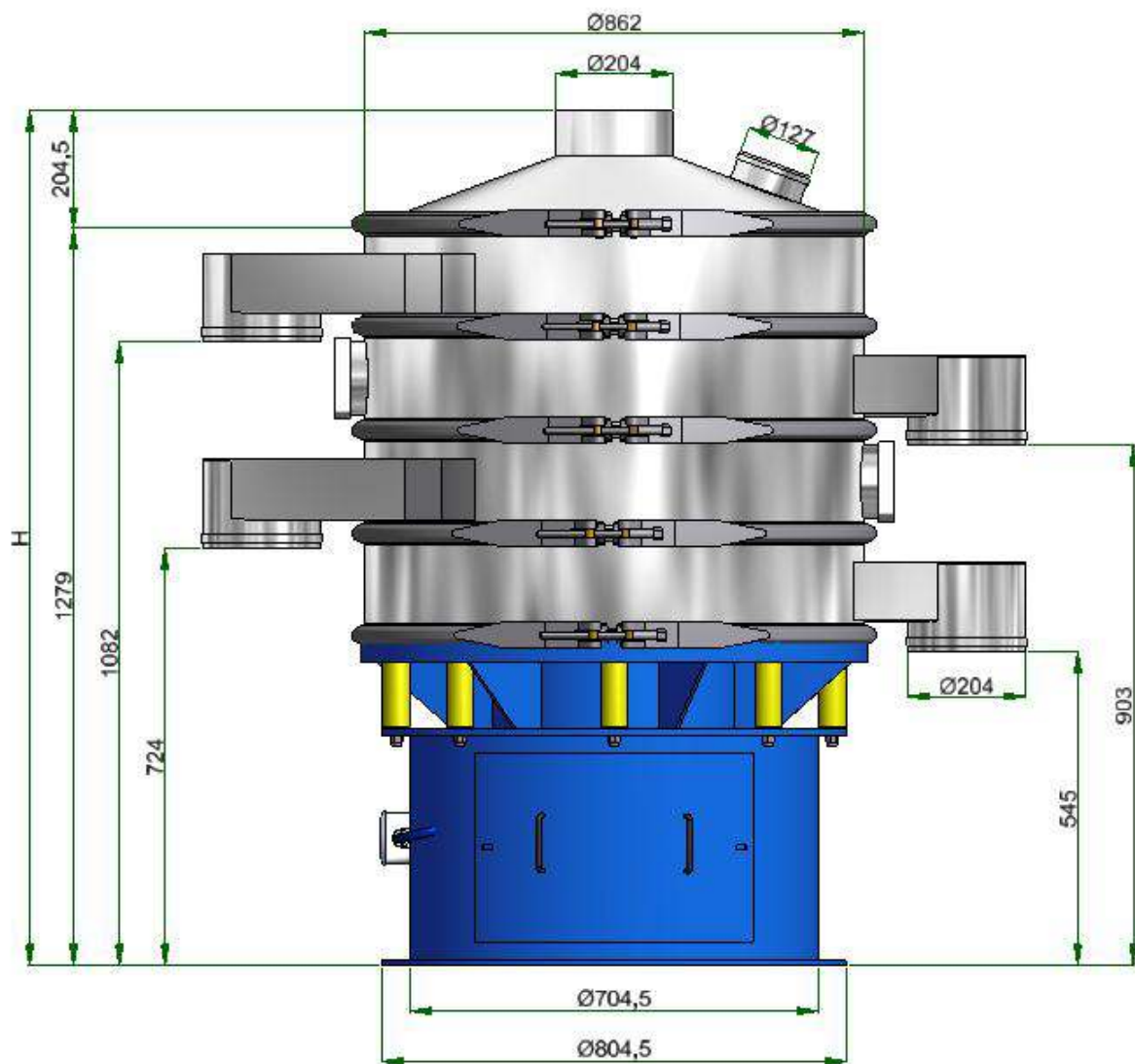

Dimensioni di ingombro separatore circolare MR 36



MODELLO MR 36

UNITA'	H		PESO	
	mm	in	kg	lb
MR 36 6 6 C	1143	45.0	315	695
MR 36 6 6 6 C	1305	51.4	345	761
MR 36 6 6 6 6 C	1484	58.4	375	827