

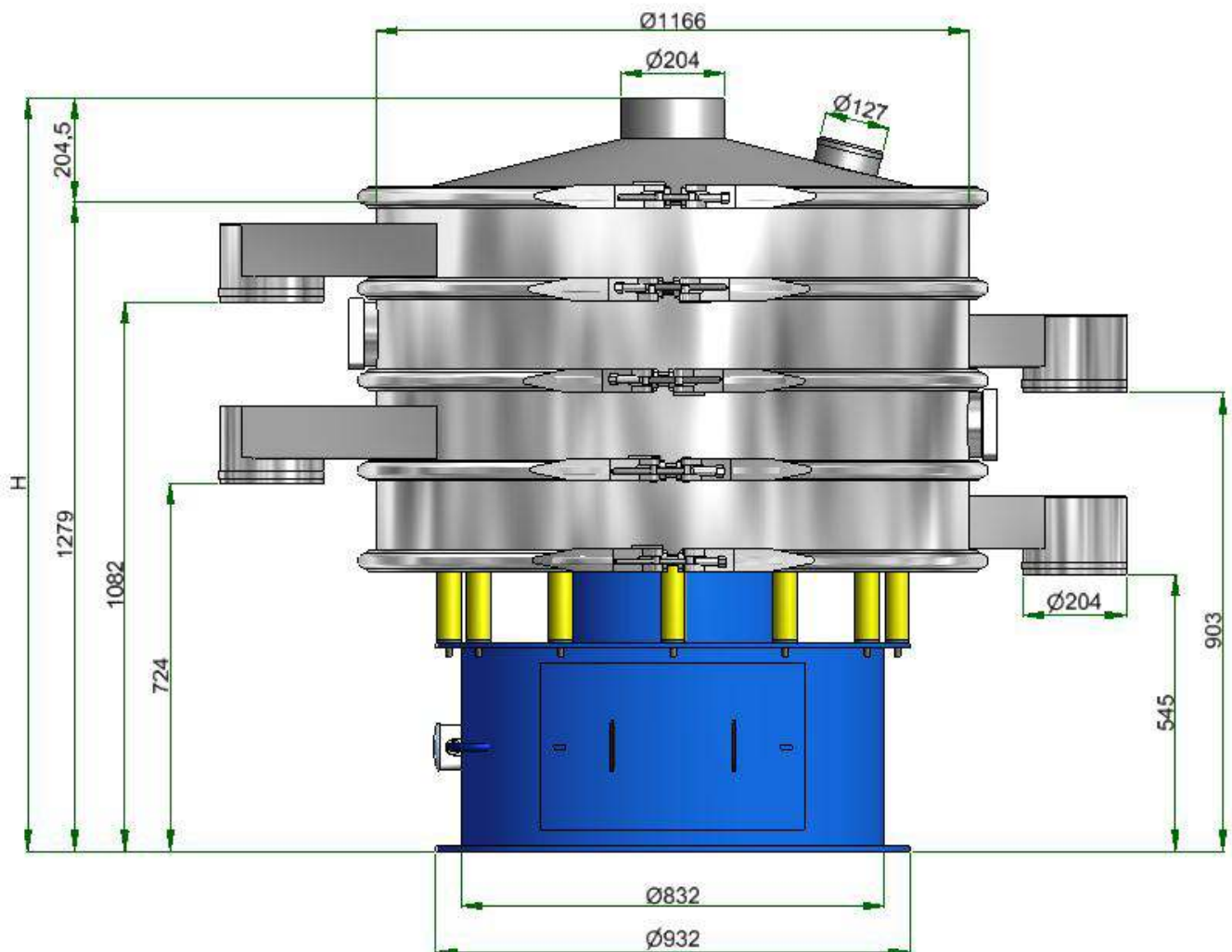

Dimensioni di ingombro separatore circolare MR 48



MODELLO MR 48

UNITA'	H		PESO	
	mm	in	kg	lb
MR 48 6 6 C	1140	44.9	370	816
MR 48 6 6 6 C	1305	51.4	430	948
MR 48 6 6 6 6 C	1485	58.5	495	1091